

# STAPLE CARTRIDGE

*Cross-Reference Guide*

FOR  
COPIERS  
& MFPS

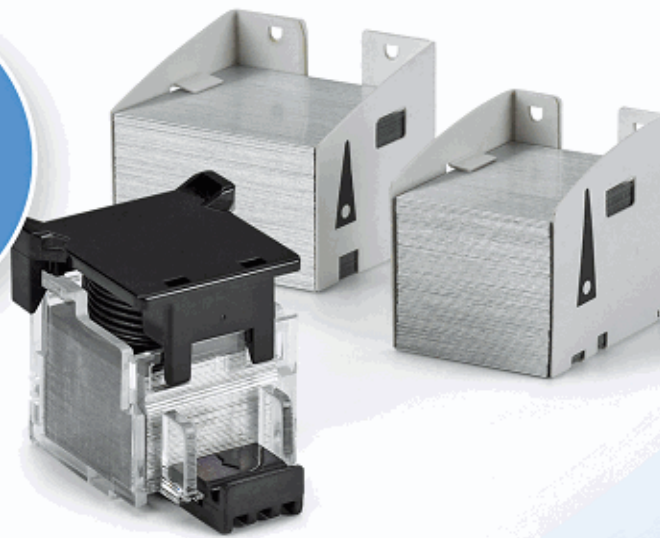

Europe 2016

*Swingline*®

**IMPORTANT NOTE:** In order to purchase the correct staples for your machine, it is important that you reference the **FINISHER** Model Identification Number. **DO NOT purchase staples based on the copier model number alone.**

To locate the FINISHER Model Identification Number, first identify the finisher unit in relation to the copier unit. In most instances you will need to separate the finisher unit from the copier unit to access the model information. The location of the FINISHER Model Identification Number will vary depending on the model manufacturer.

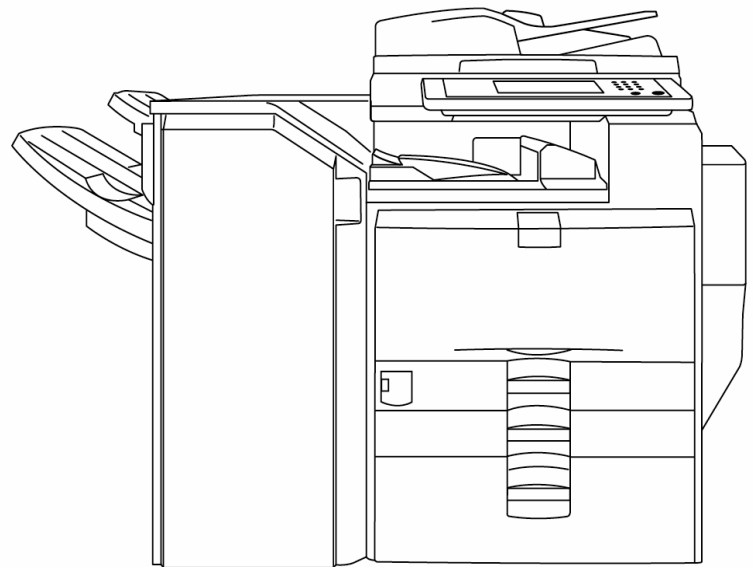

Finisher Unit

Copier/MFP Unit

## Sharp

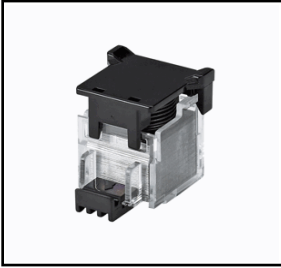

### Katun Part Number

**36749**

Type      Size (mm)  
D2          26x25x32

### Your Price:

Finisher	Model	OEM Part Number
AR- FN 11		STAPLE 600
	AR 651	✓
	AR 810	✓

AR- FN 12		STAPLE 600
	AR 651	✓
	AR 810	✓

AR- FN 9		AR-SC3
	AR 650	✓

AR-F16		AR-SC3
	AR M 550	✓
	AR M 620	✓
	AR M 700	✓
	MX M 550	✓
	MX M 620	✓
	MX M 700	✓

MX- FN 10		AR-SC3
	MX 2600	✓
	MX 2610	✓
	MX 2640	✓
	MX 3100	✓
	MX 3110	✓
	MX 3140	✓
	MX 3610	✓
	MX 3640	✓
	MX 4100	✓
	MX 4101	✓
	MX 4110	✓
	MX 4111	✓
	MX 4112	✓
	MX 4140	✓
	MX 4141	✓
	MX 5000	✓
	MX 5001	✓
	MX 5110	✓
	MX 5111	✓
	MX 5112	✓
	MX 5140	✓
	MX 5141	✓
	MX M 282	✓
	MX M 283	✓
	MX M 362	✓
	MX M 363	✓
	MX M 452	✓
	MX M 453	✓
	MX M 502	✓
	MX M 503	✓

## Sharp

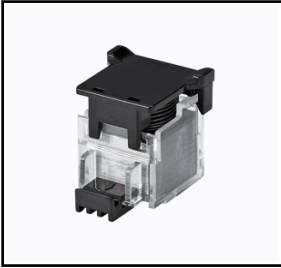

### Katun Part Number

**36749**

Type      Size (mm)  
D2          26x25x32

Your Price:

Finisher	Model	OEM Part Number
MX- FN 18		AR-SC3
	MX 4100	✓
	MX 4101	✓
	MX 4110	✓
	MX 4111	✓
	MX 4112	✓
	MX 5001	✓
	MX 5110	✓
	MX 5111	✓
	MX 5112	✓
	MX M 364	✓
	MX M 365	✓
	MX M 464	✓
	MX M 465	✓
	MX M 564	✓
MX M 565	✓	
MX- FN20		AR-SC3
	MX 6240	✓
	MX 7040	✓
	MX M 654	✓
	MX M 754	✓
MX- FNX 3		AR-SC3
	MX 5500	✓
	MX 6200	✓
	MX 6201	✓
	MX 7000	✓
	MX 7001	✓
MX- FNX 4		AR-SC3
	MX 5500	✓
	MX 6200	✓
	MX 6201	✓
	MX 7000	✓
	MX 7001	✓

## Sharp

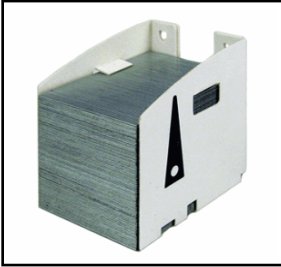

### Katun Part Number

**37413**

Type	Size (mm)
E1	35x28x35

### Your Price:

Finisher	Model	OEM Part Number
AR- FN 1		SF-SC11
	AR 280	✓
	AR 285	✓
	AR 335	✓
AR- FN 1 N		SF-SC11
	AR 287	✓
	AR 337	✓
	AR 405	✓
	AR 407	✓
AR- FN 11		STAPLE 700
	AR 651	✓
	AR 810	✓
AR- FN 12		STAPLE 700
	AR 651	✓
	AR 810	✓
AR- FN 3		SF-SC11
	AR 501	✓
	AR 505	✓
	AR 507	✓
AR- FN 8		SF-SC11
	AR 650	✓
AR- FN 9		SF-SC11
	AR 650	✓
AR- SS 2		SF-SC11
	AR C 150	✓
	AR C 160	✓
	AR C 250	✓
	AR C 270	✓
AR-F15		SF-SC11
	AR M 550	✓
	AR M 620	✓
	AR M 700	✓
	MX M 550	✓
	MX M 620	✓
	MX M 700	✓

## Sharp

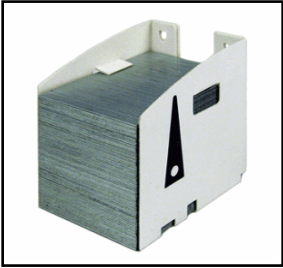

### Katun Part Number

**37413**

Type      Size (mm)  
E1          35x28x35

### Your Price:

<u>Finisher</u>	<u>Model</u>	<u>OEM Part Number</u>
MX- FN 15		SF-SC11
	MX M 623	✓
	MX M 753	✓
MX- FN 16		SF-SC11
	MX M 623	✓
	MX M 753	✓
SD- F 202		SF-SC11
	SD 4085	✓
SF- S 55		SF-SC11
	SD 2260	✓
	SD 2275	✓
SF- S 55 N		SF-SC11
	SD 2275	✓
SF- S 56		SF-SC11
	SF 2530	✓
	SF 2540	✓

## Sharp

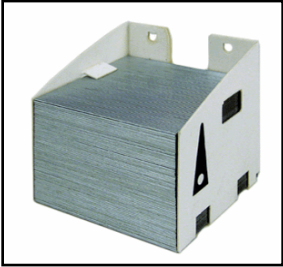

Finisher	Model	OEM Part Number
MX- FN 14		MX-SC10
	MX M 623	✓
	MX M 753	✓

### Katun Part Number

**37414**

Type	Size (mm)
G1	35x40x35

Your Price:

## Sharp

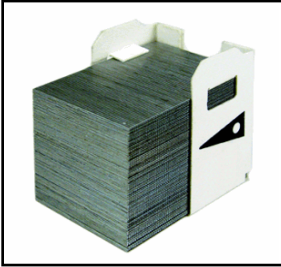

### Katun Part Number

**37416**

Type      Size (mm)  
J1          35x28x33

### Your Price:

Finisher	Model	OEM Part Number
AR- F 14		AR-SC2
	AR M 236	✓
	AR M 237	✓
	AR M 276	✓
	AR M 277	✓
AR- FN 7		AR-SC2
	AR M 350	✓
	AR M 351	✓
	AR M 355	✓
	AR M 450	✓
	AR M 451	✓
	AR P 350	✓
	AR P 450	✓
	MX M 350	✓
	MX M 450	✓
MX- FN 11		AR-SC2
	MX 4100	✓
	MX 4101	✓
	MX 4110	✓
	MX 4111	✓
	MX 4112	✓
	MX 4140	✓
	MX 4141	✓
	MX 5000	✓
	MX 5001	✓
	MX 5110	✓
	MX 5111	✓
	MX 5112	✓
	MX 5140	✓
	MX 5141	✓
	MX M 282	✓
	MX M 283	✓
	MX M 362	✓
	MX M 363	✓
	MX M 364	✓
	MX M 365	✓
	MX M 452	✓
	MX M 453	✓
	MX M 464	✓
	MX M 465	✓
	MX M 502	✓
	MX M 503	✓
	MX M 564	✓
	MX M 565	✓
	MX- FN 18	
MX 4100		✓
MX 4101		✓
MX 4110		✓
MX 4111		✓
MX 4112		✓
MX 5001		✓
MX 5110		✓
MX 5111		✓
MX 5112		✓
MX M 364		✓
MX M 365		✓
MX M 464		✓
MX M 465		✓
MX M 564	✓	
MX M 565	✓	



## Sharp

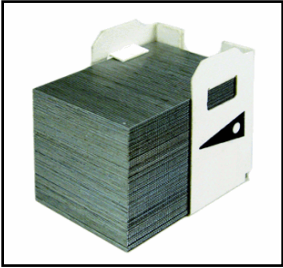

### Katun Part Number

**37416**

Type      Size (mm)  
J1          35x28x33

Your Price:

Finisher	Model	OEM Part Number
MX- FN 29		AR-SC2
	MX 3050	✓
	MX 3060	✓
	MX 3070	✓
	MX 3550	✓
	MX 3560	✓
	MX 3570	✓
	MX 4050	✓
	MX 4060	✓
	MX 4070	✓
	MX 5050	✓
	MX 5070	✓
MX 6050	✓	
MX 6070	✓	
MX- FN19		AR-SC2
	MX 6240	✓
	MX 7040	✓
	MX M 654	✓
MX M 754	✓	
MX- FN20		AR-SC2
	MX 6240	✓
	MX 7040	✓
	MX M 654	✓
MX M 754	✓	
MX- FN24		AR-SC2
	MX M 1204	✓
MX M 904	✓	
MX- FN25		AR-SC2
MX M 904	✓	
MX- FNX 2		AR-SC2
	MX 2300	✓
	MX 2700	✓
MX 4500	✓	
MX- FNX 2P		AR-SC2
	MX 3501	✓
MX 4501	✓	
MX- FNX 3		AR-SC2
	MX 5500	✓
	MX 6200	✓
	MX 6201	✓
	MX 7000	✓
MX 7001	✓	

## Sharp

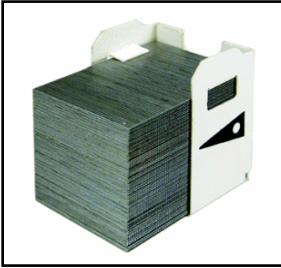

### Katun Part Number

**37416**

Type      Size (mm)  
J1          35x28x33

Your Price:

Finisher	Model	OEM Part Number	
MX- FNX 4		AR-SC2	
	MX 5500		✓
	MX 6200		✓
	MX 6201		✓
	MX 7000		✓
	MX 7001		✓
MX- FNX 6		AR-SC2	
	MX M 1100		✓
	MX M 850		✓
	MX M 950		✓
MX- FNX 7		AR-SC2	
	MX M 1100		✓
	MX M 850		✓
	MX M 950		✓
N/A		8R12915	AR-SC2
	AR BC 260	✓	✓
	AR BC 320	✓	✓
	AR C 260	✓	✓
	Z 88	✓	✓

## Sharp

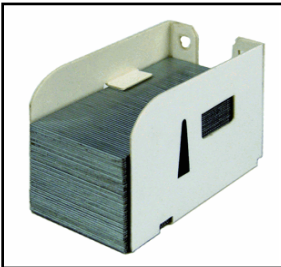

### Katun Part Number

**37417**

Type      Size (mm)  
L1          35x21x25

Your Price:

Finisher	Model	OEM Part Number	
AR- FN 4		AR-SC1	
	AR C 160		✓
	AR C 250		✓
	AR C 270		✓
	AR C 330		✓
AR- FN 5		AR-SC1	
	AR 235		✓
	AR 275		✓
AR- FN 6		AR-SC1	
	AR M 350		✓
	AR M 351		✓
	AR M 355		✓
	AR M 450		✓
	AR M 451		✓
	MX M 350		✓
	MX M 450		✓

## Sharp

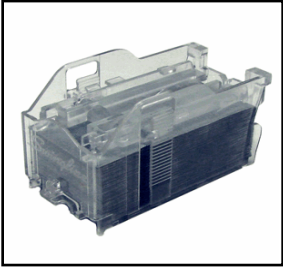

### Katun Part Number

**37664**

Type	Size (mm)
P1	61.5x33x34

Your Price:

Finisher	Model	OEM Part Number
		MX-SCX1
MX- FN 10		
	MX 2600	✓
	MX 2610	✓
	MX 2640	✓
	MX 3100	✓
	MX 3110	✓
	MX 3140	✓
	MX 3610	✓
	MX 3640	✓
	MX 4100	✓
	MX 4101	✓
	MX 4110	✓
	MX 4111	✓
	MX 4112	✓
	MX 4140	✓
	MX 4141	✓
	MX 5000	✓
	MX 5001	✓
	MX 5110	✓
	MX 5111	✓
	MX 5112	✓
	MX 5140	✓
	MX 5141	✓
	MX M 282	✓
	MX M 283	✓
	MX M 362	✓
	MX M 363	✓
	MX M 452	✓
	MX M 453	✓
	MX M 502	✓
MX M 503	✓	
		MX-SCX1
MX- FN 12		
	DX C 310	✓
	DX C 311	✓
	DX C 380	✓
	DX C 381	✓
	DX C 400	✓
	DX C 401	✓
	MX B 381	✓
	MX B 382	✓
	MX B 401	✓
	MX B 402	✓
	MX C 310	✓
	MX C 311	✓
	MX C 312	✓
	MX C 380	✓
	MX C 381	✓
	MX C 382	✓
	MX C 401	✓
	MX C 402	✓
MX- FN 13		
	AR 5726	✓
	AR 5731	✓
	MX M 260	✓
MX M 310	✓	
		MX-SCX1
MX- FN 14		
	MX M 623	✓
MX M 753	✓	

## Sharp

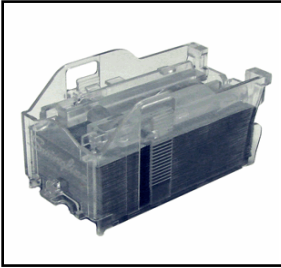

### Katun Part Number

**37664**

Type      Size (mm)  
P1          61.5x33x34

**Your Price:**

Finisher	Model	OEM Part Number
		MX-SCX1
MX- FN 23		
	MX M 264	✓
	MX M 314	✓
	MX M 354	✓
		MX-SCX1
MX- FN 26		
	MX M 265	✓
	MX M 266	✓
	MX M 315	✓
	MX M 316	✓
	MX M 356	✓
		MX-SCX1
MX- FN 27		
	MX 3050	✓
	MX 3060	✓
	MX 3070	✓
	MX 3550	✓
	MX 3560	✓
	MX 3570	✓
	MX 4050	✓
	MX 4060	✓
	MX 4070	✓
	MX 5050	✓
	MX 5070	✓
	MX 6050	✓
	MX 6070	✓
		MX-SCX1
MX- FN 28		
	MX 3050	✓
	MX 3060	✓
	MX 3070	✓
	MX 3550	✓
	MX 3560	✓
	MX 3570	✓
	MX 4050	✓
	MX 4060	✓
	MX 4070	✓
	MX 5050	✓
	MX 5070	✓
	MX 6050	✓
	MX 6070	✓
		MX-SCX1
MX- FN 29		
	MX 3050	✓
	MX 3060	✓
	MX 3070	✓
	MX 3550	✓
	MX 3560	✓
	MX 3570	✓
	MX 4050	✓
	MX 4060	✓
	MX 4070	✓
	MX 5050	✓
	MX 5070	✓
	MX 6050	✓
	MX 6070	✓
		MX-SCX1
MX- FN17		
	MX 2010	✓
	MX 2310	✓
	MX 2314	✓
	MX 2610	✓
	MX 2614	✓
	MX 2615	✓
	MX 2640	✓

*\*\*This document does not constitute an agreement for a price or sale. Prices shown are subject to change without notice. Contact your Katun sales representative for the current pricing information.*

## Sharp

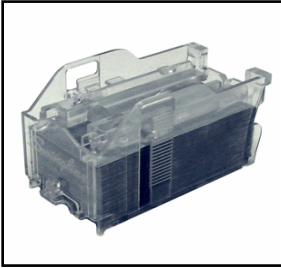

### Katun Part Number

**37664**

Type      Size (mm)  
P1          61.5x33x34

Your Price:

Finisher	Model	OEM Part Number
MX- FN17	MX 3110	MX-SCX1 ✓
	MX 3111	✓
	MX 3114	✓
	MX 3115	✓
	MX 3140	✓
	MX 3610	✓
	MX 3640	✓
	MX M 364	✓
	MX M 365	✓
	MX M 464	✓
	MX M 465	✓
	MX M 564	✓
	MX M 565	✓
MX- FN22		MX-SCX1
	MX 6500	✓
	MX 7500	✓
	MX M 1054	✓
	MX M 1204	✓
	MX M 654	✓
	MX M 754	✓
	MX M 904	✓
MX- FNX 1		MX-SCX1
	MX 1800	✓
	MX 2300	✓
	MX 2700	✓
	MX 3500	✓
	MX 4500	✓
MX- FNX 9		MX-SCX1
	MX 2301	✓
	MX 2600	✓
	MX 3100	✓
	MX 4101	✓
	MX 4110	✓
	MX 4111	✓
	MX 4140	✓
	MX 4141	✓
	MX 5000	✓
	MX 5110	✓
	MX 5111	✓
	MX 5140	✓
	MX 5141	✓
	MX M 282	✓
	MX M 362	✓
	MX M 363	✓
	MX M 452	✓
	MX M 453	✓
	MX M 502	✓
MX M 503	✓	
N/A		MX-SCX1
	DX C 310	✓
	DX C 311	✓
	DX C 400	✓
	DX C 401	✓
	MX 1810	✓
	MX 2301	✓
	MX 2310	✓
	MX 2610	✓
	MX 3110	✓
	MX 3111	✓
	MX 3610	✓
	MX B 380	✓
	MX B 381	✓

\*\*This document does not constitute an agreement for a price or sale. Prices shown are subject to change without notice. Contact your Katun sales representative for the current pricing information.

## Sharp

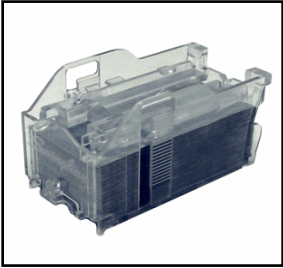

### Katun Part Number

**37664**

Type      Size (mm)  
P1        61.5x33x34

Your Price:

Finisher	Model	OEM Part Number
----------	-------	-----------------

Finisher	Model	OEM Part Number
N/A		MX-SCX1
	MX B 382	✓
	MX B 400	✓
	MX B 401	✓
	MX B 402	✓
	MX C 310	✓
	MX C 311	✓
	MX C 312	✓
	MX C 380	✓
	MX C 381	✓
	MX C 400	✓
	MX C 401	✓
	MX M 260	✓
	MX M 310	✓

## Sharp

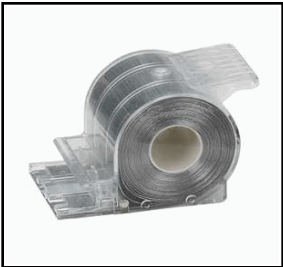

### Katun Part Number

**37796**

Type      Size (mm)  
N1        76x46x46

Your Price:

Finisher	Model	OEM Part Number
----------	-------	-----------------

Finisher	Model	OEM Part Number
MX- FN21		MX-SCX2
	MX 6240	✓
	MX 6500	✓
	MX 7040	✓
	MX 7500	✓
	MX M 1054	✓
	MX M 1204	✓
	MX M 654	✓
	MX M 754	✓
	MX M 904	✓
MX- FN22		MX-SCX2
	MX 6500	✓
	MX 7500	✓
	MX M 1054	✓
	MX M 1204	✓
	MX M 654	✓
	MX M 754	✓
	MX M 904	✓
MX- FNX 5		MX-SCX2
	MX M 1100	✓
	MX M 850	✓
	MX M 950	✓
MX- FNX 6		MX-SCX2
	MX M 1100	✓
	MX M 850	✓
	MX M 950	✓

## Sharp

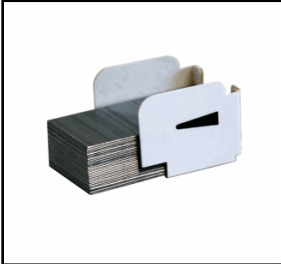

<u>Finisher</u>	<u>Model</u>	<u>OEM Part Number</u>
MX- FN25		MX-SCX3
	MX M 904	✓
MX- FNX 7		MX-SCX3
	MX M 1100	✓
	MX M 850	✓
	MX M 950	✓

### Katun Part Number

**47034**

<u>Type</u>	<u>Size (mm)</u>
X1	36x21x12

**Your Price:**