

STAPLE CARTRIDGE

Cross-Reference Guide

FOR
COPIERS
& MFPS

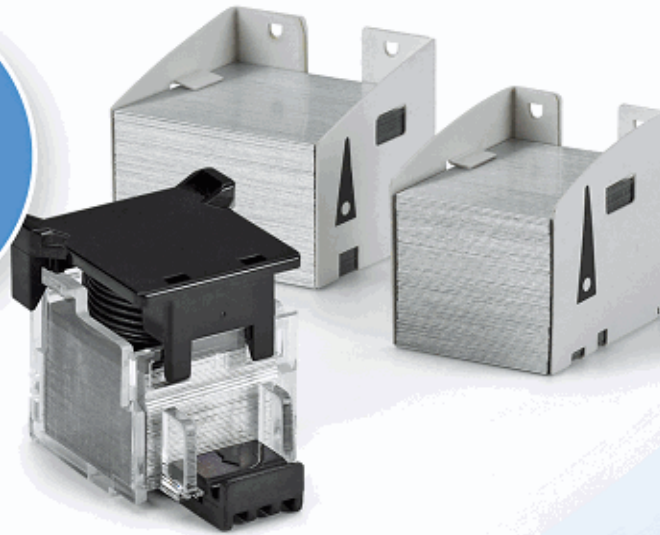

Europe 2018

Swingline®

IMPORTANT NOTE: In order to purchase the correct staples for your machine, it is important that you reference the **FINISHER** Model Identification Number. **DO NOT purchase staples based on the copier model number alone.**

To locate the FINISHER Model Identification Number, first identify the finisher unit in relation to the copier unit. In most instances you will need to separate the finisher unit from the copier unit to access the model information. The location of the FINISHER Model Identification Number will vary depending on the model manufacturer.

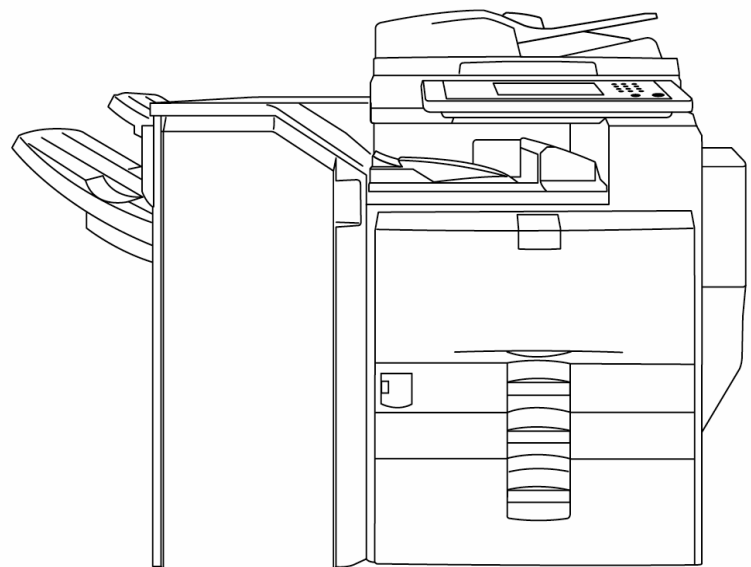

Finisher Unit

Copier/MFP Unit

Sharp

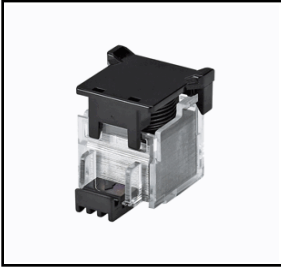

Katun Part Number

36749

Type Size (mm)
D2 26x25x32

Your Price:

Finisher	Model	OEM Part Number
AR- FN 11		STAPLE 600
	AR 651	✓
	AR 810	✓
AR- FN 12		STAPLE 600
	AR 651	✓
	AR 810	✓
AR- FN 9		AR-SC3
	AR 650	✓
AR-F16		AR-SC3
	AR M 550	✓
	AR M 620	✓
	AR M 700	✓
	MX M 550	✓
	MX M 620	✓
	MX M 700	✓
MX- FN 10		AR-SC3
	AR M 460	✓
	AR M 560	✓
	MX 2600	✓
	MX 2610	✓
	MX 2640	✓
	MX 3100	✓
	MX 3110	✓
	MX 3140	✓
	MX 3610	✓
	MX 3640	✓
	MX 4100	✓
	MX 4101	✓
	MX 4110	✓
	MX 4111	✓
	MX 4112	✓
	MX 4140	✓
	MX 4141	✓
	MX 5000	✓
	MX 5001	✓
	MX 5110	✓
	MX 5111	✓
	MX 5112	✓
	MX 5140	✓
	MX 5141	✓
	MX M 282	✓
	MX M 283	✓
	MX M 362	✓
	MX M 363	✓
	MX M 452	✓
	MX M 453	✓
	MX M 502	✓
MX M 503	✓	

***This document does not constitute an agreement for a price or sale. Prices shown are subject to change without notice. Contact your Katun sales representative for the current pricing information.*

Sharp

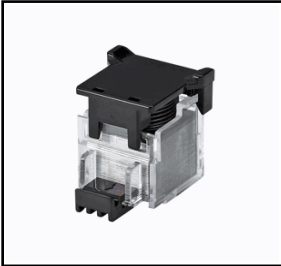

Katun Part Number

36749

Type Size (mm)
D2 26x25x32

Your Price:

Finisher	Model	OEM Part Number
MX- FN 18		AR-SC3
	AR M 460	✓
	AR M 560	✓
	MX 4100	✓
	MX 4101	✓
	MX 4110	✓
	MX 4111	✓
	MX 4112	✓
	MX 5001	✓
	MX 5110	✓
	MX 5111	✓
	MX 5112	✓
	MX M 364	✓
	MX M 365	✓
	MX M 464	✓
	MX M 465	✓
MX M 564	✓	
MX M 565	✓	
MX- FN20		AR-SC3
	MX 6240	✓
	MX 6580	✓
	MX 7040	✓
	MX 7580	✓
	MX M 654	✓
MX- FNX 3		AR-SC3
	MX 5500	✓
	MX 6200	✓
	MX 6201	✓
	MX 7000	✓
MX- FNX 4		AR-SC3
	MX 5500	✓
	MX 6200	✓
	MX 6201	✓
	MX 7000	✓
	MX 7001	✓

Sharp

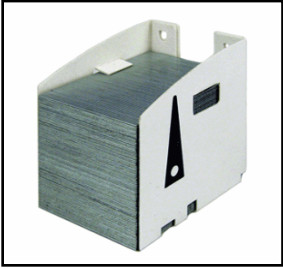

Katun Part Number

37413

Type	Size (mm)
E1	35x28x35

Your Price:

Finisher	Model	OEM Part Number
AR- FN 1		SF-SC11
	AR 280	✓
	AR 285	✓
	AR 335	✓
AR- FN 1 N		SF-SC11
	AR 287	✓
	AR 337	✓
	AR 405	✓
	AR 407	✓
AR- FN 11		STAPLE 700
	AR 651	✓
	AR 810	✓
AR- FN 12		STAPLE 700
	AR 651	✓
	AR 810	✓
AR- FN 3		SF-SC11
	AR 501	✓
	AR 505	✓
	AR 507	✓
AR- FN 8		SF-SC11
	AR 650	✓
AR- FN 9		SF-SC11
	AR 650	✓
AR- SS 2		SF-SC11
	AR C 150	✓
	AR C 160	✓
	AR C 250	✓
	AR C 270	✓
AR-F15		SF-SC11
	AR M 550	✓
	AR M 620	✓
	AR M 700	✓
	MX M 550	✓
	MX M 620	✓
	MX M 700	✓

Sharp

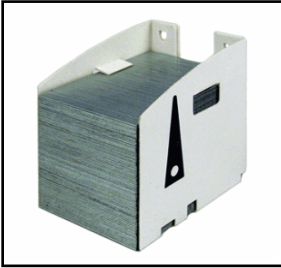

Katun Part Number

37413

Type	Size (mm)
E1	35x28x35

Your Price:

<u>Finisher</u>	<u>Model</u>	<u>OEM Part Number</u>
		SF-SC11
MX- FN 15		
	MX M 623	✓
	MX M 753	✓
		SF-SC11
MX- FN 16		
	MX M 623	✓
	MX M 753	✓
		SF-SC11
SD- F 202		
	SD 4085	✓
		SF-SC11
SF- S 55		
	SD 2260	✓
	SD 2275	✓
		SF-SC11
SF- S 55 N		
	SD 2275	✓
		SF-SC11
SF- S 56		
	SF 2530	✓
	SF 2540	✓

Sharp

Finisher

Model

OEM Part Number

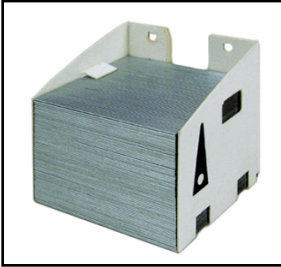

<u>Finisher</u>	<u>Model</u>	<u>OEM Part Number</u>
MX- FN 14		MX-SC10
	MX M 623	✓
	MX M 753	✓

Katun Part Number

37414

<u>Type</u>	<u>Size (mm)</u>
G1	35x40x35

Your Price:

Sharp

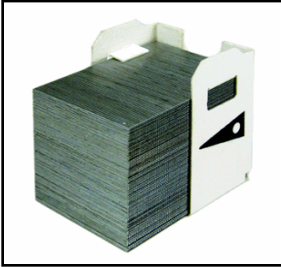

Katun Part Number

37416

Type	Size (mm)
J1	35x28x33

Your Price:

Finisher	Model	OEM Part Number
AR- F 14		AR-SC2
	AR M 236	✓
	AR M 237	✓
	AR M 276	✓
	AR M 277	✓
AR- FN 7		AR-SC2
	AR M 350	✓
	AR M 351	✓
	AR M 355	✓
	AR M 450	✓
	AR M 451	✓
	AR P 350	✓
	AR P 450	✓
	MX M 350	✓
	MX M 450	✓
MX- FN 11		AR-SC2
	AR M 460	✓
	AR M 560	✓
	MX 4100	✓
	MX 4101	✓
	MX 4110	✓
	MX 4111	✓
	MX 4112	✓
	MX 4140	✓
	MX 4141	✓
	MX 5000	✓
	MX 5001	✓
	MX 5110	✓
	MX 5111	✓
	MX 5112	✓
	MX 5140	✓
	MX 5141	✓
	MX M 282	✓
	MX M 283	✓
	MX M 362	✓
	MX M 363	✓
	MX M 364	✓
	MX M 365	✓
	MX M 452	✓
	MX M 453	✓
	MX M 464	✓
	MX M 465	✓
	MX M 502	✓
	MX M 503	✓
	MX M 564	✓
	MX M 565	✓
	MX- FN 18	
AR M 460		✓
AR M 560		✓
MX 4100		✓
MX 4101		✓
MX 4110		✓
MX 4111		✓
MX 4112		✓
MX 5001		✓
MX 5110		✓
MX 5111		✓
MX 5112		✓
MX M 364		✓

Sharp

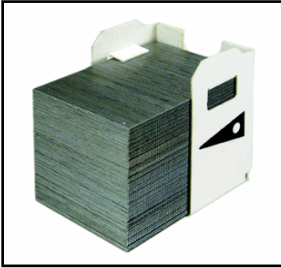

Katun Part Number

37416

Type	Size (mm)
J1	35x28x33

Your Price:

Finisher	Model	OEM Part Number
MX- FN 18	MX M 565	AR-SC2 ✓
MX- FN 29	MX 2630	AR-SC2 ✓
	MX 3050	✓
	MX 3060	✓
	MX 3070	✓
	MX 3550	✓
	MX 3560	✓
	MX 3570	✓
	MX 4050	✓
	MX 4060	✓
	MX 4070	✓
	MX 5050	✓
	MX 5070	✓
	MX 6050	✓
MX 6070	✓	
MX- FN19	MX 6240	AR-SC2 ✓
	MX 6580	✓
	MX 7040	✓
	MX 7580	✓
	MX M 654	✓
	MX M 754	✓
MX- FN20	MX 6240	AR-SC2 ✓
	MX 6580	✓
	MX 7040	✓
	MX 7580	✓
	MX M 654	✓
MX- FN24	MX M 1204	AR-SC2 ✓
	MX M 904	✓
	MX M 905	✓
MX- FN25	MX M 904	AR-SC2 ✓
	MX M 905	✓
MX- FNX 2	MX 2300	AR-SC2 ✓
	MX 2700	✓
	MX 4500	✓
MX- FNX 2P	MX 3501	AR-SC2 ✓
	MX 4501	✓
MX- FNX 3	MX 5500	AR-SC2 ✓
	MX 6200	✓
	MX 6201	✓
	MX 7000	✓

Sharp

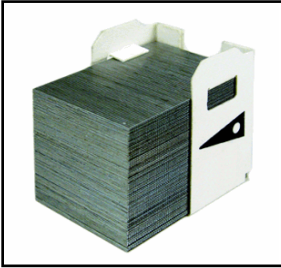

Katun Part Number

37416

Type Size (mm)
J1 35x28x33

Your Price:

Finisher	Model	OEM Part Number	
MX- FNX 3	MX 7001	AR-SC2 ✓	
MX- FNX 4		AR-SC2	
	MX 5500	✓	
	MX 6200	✓	
	MX 6201	✓	
	MX 7000	✓	
MX- FNX 6		AR-SC2	
	MX M 1100	✓	
	MX M 850	✓	
	MX M 950	✓	
MX- FNX 7		AR-SC2	
	MX M 1100	✓	
	MX M 850	✓	
	MX M 950	✓	
N/A		8R12915	AR-SC2
	AR BC 260	✓	✓
	AR BC 320	✓	✓
	AR C 260	✓	✓
	Z 88	✓	✓

Sharp

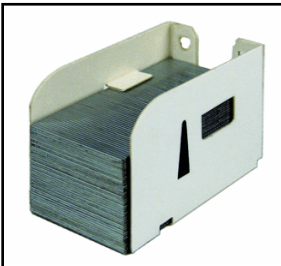

Katun Part Number

37417

Type Size (mm)
L1 35x21x25

Your Price:

Finisher	Model	OEM Part Number
AR- FN 4		AR-SC1
	AR C 160	✓
	AR C 250	✓
	AR C 270	✓
	AR C 330	✓
AR- FN 5		AR-SC1
	AR 235	✓
	AR 275	✓
AR- FN 6		AR-SC1
	AR M 350	✓
	AR M 351	✓
	AR M 355	✓
	AR M 450	✓
	AR M 451	✓
	MX M 350	✓
MX M 450	✓	

Sharp

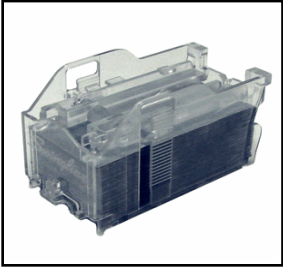

Katun Part Number

37664

Type	Size (mm)
P1	61.5x33x34

Your Price:

Finisher	Model	OEM Part Number	
		MX-SCX1	
MX- FN 10	AR M 460	✓	
	AR M 560	✓	
	MX 2600	✓	
	MX 2610	✓	
	MX 2640	✓	
	MX 3100	✓	
	MX 3110	✓	
	MX 3140	✓	
	MX 3610	✓	
	MX 3640	✓	
	MX 4100	✓	
	MX 4101	✓	
	MX 4110	✓	
	MX 4111	✓	
	MX 4112	✓	
	MX 4140	✓	
	MX 4141	✓	
	MX 5000	✓	
	MX 5001	✓	
	MX 5110	✓	
	MX 5111	✓	
	MX 5112	✓	
	MX 5140	✓	
	MX 5141	✓	
	MX M 282	✓	
	MX M 283	✓	
	MX M 362	✓	
	MX M 363	✓	
	MX M 452	✓	
	MX M 453	✓	
MX M 502	✓		
MX M 503	✓		
		MX-SCX1	
MX- FN 12	DX C 310	✓	
	DX C 311	✓	
	DX C 380	✓	
	DX C 381	✓	
	DX C 400	✓	
	DX C 401	✓	
	MX B 381	✓	
	MX B 382	✓	
	MX B 401	✓	
	MX B 402	✓	
	MX C 310	✓	
	MX C 311	✓	
	MX C 312	✓	
	MX C 380	✓	
	MX C 381	✓	
	MX C 382	✓	
	MX C 401	✓	
	MX C 402	✓	
			MX-SCX1
	MX- FN 13	AR 5726	✓
AR 5731		✓	
MX M 260		✓	
MX M 310		✓	
		MX-SCX1	
MX- FN 14	MX M 623	✓	
	MX M 753	✓	

Sharp

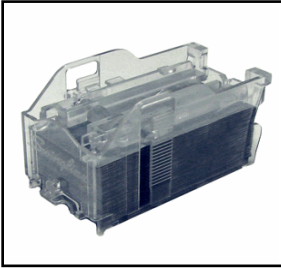

Katun Part Number

37664

Type Size (mm)
P1 61.5x33x34

Your Price:

Finisher	Model	OEM Part Number
MX- FN 23		MX-SCX1
	MX M 264	✓
	MX M 314	✓
	MX M 354	✓
MX- FN 26		MX-SCX1
	MX M 265	✓
	MX M 266	✓
	MX M 315	✓
	MX M 316	✓
MX- FN 27		MX-SCX1
	MX 3050	✓
	MX 3060	✓
	MX 3070	✓
	MX 3550	✓
	MX 3560	✓
	MX 3570	✓
	MX 4050	✓
	MX 4060	✓
	MX 4070	✓
	MX 5050	✓
	MX 5070	✓
	MX 6050	✓
MX 6070	✓	
MX- FN 28		MX-SCX1
	MX 3050	✓
	MX 3060	✓
	MX 3070	✓
	MX 3550	✓
	MX 3560	✓
	MX 3570	✓
	MX 4050	✓
	MX 4060	✓
	MX 4070	✓
	MX 5050	✓
	MX 5070	✓
	MX 6050	✓
MX 6070	✓	
MX- FN 29		MX-SCX1
	MX 2630	✓
	MX 3050	✓
	MX 3060	✓
	MX 3070	✓
	MX 3550	✓
	MX 3560	✓
	MX 3570	✓
	MX 4050	✓
	MX 4060	✓
	MX 4070	✓
	MX 5050	✓
	MX 5070	✓
MX 6050	✓	
MX 6070	✓	
MX- FN 17		MX-SCX1
	AR M 460	✓
	AR M 560	✓
	MX 2010	✓
	MX 2310	✓
	MX 2314	✓
MX 2610	✓	

**This document does not constitute an agreement for a price or sale. Prices shown are subject to change without notice. Contact your Katun sales representative for the current pricing information.

Sharp

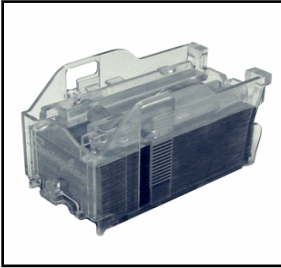

Katun Part Number

37664

Type Size (mm)
P1 61.5x33x34

Your Price:

Finisher	Model	OEM Part Number
MX- FN17	MX 2614	MX-SCX1 ✓
	MX 2615	✓
	MX 2640	✓
	MX 3110	✓
	MX 3111	✓
	MX 3114	✓
	MX 3115	✓
	MX 3140	✓
	MX 3610	✓
	MX 3640	✓
	MX M 364	✓
	MX M 365	✓
	MX M 464	✓
	MX M 465	✓
MX M 564	✓	
MX M 565	✓	
MX- FN22		MX-SCX1
	MX 6500	✓
	MX 6580	✓
	MX 7500	✓
	MX 7580	✓
	MX M 1054	✓
	MX M 1055	✓
	MX M 1204	✓
	MX M 1205	✓
	MX M 1205	✓
	MX M 654	✓
	MX M 754	✓
	MX M 904	✓
	MX M 905	✓
MX- FNX 1		MX-SCX1
	MX 1800	✓
	MX 2300	✓
	MX 2700	✓
	MX 3500	✓
	MX 3501	✓
	MX 4500	✓
MX 4501	✓	
MX- FNX 9		MX-SCX1
	MX 2301	✓
	MX 2600	✓
	MX 3100	✓
	MX 4101	✓
	MX 4110	✓
	MX 4111	✓
	MX 4140	✓
	MX 4141	✓
	MX 5000	✓
	MX 5110	✓
	MX 5111	✓
	MX 5140	✓
	MX 5141	✓
	MX M 282	✓
	MX M 362	✓
	MX M 363	✓
	MX M 452	✓
	MX M 453	✓
MX M 502	✓	
MX M 503	✓	
N/A		MX-SCX1
	DX C 310	✓
	DX C 311	✓
	DX C 400	✓
	DX C 401	✓
MX 1810	✓	

**This document does not constitute an agreement for a price or sale. Prices shown are subject to change without notice. Contact your Katun sales representative for the current pricing information.

Sharp

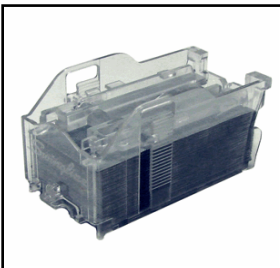

Katun Part Number

37664

Type	Size (mm)
P1	61.5x33x34

Your Price:

<u>Finisher</u>	<u>Model</u>	<u>OEM Part Number</u>
N/A		MX-SCX1
	MX 2301	✓
	MX 2310	✓
	MX 2610	✓
	MX 3110	✓
	MX 3111	✓
	MX 3610	✓
	MX B 380	✓
	MX B 381	✓
	MX B 382	✓
	MX B 400	✓
	MX B 401	✓
	MX B 402	✓
	MX C 310	✓
	MX C 311	✓
	MX C 312	✓
	MX C 380	✓
	MX C 381	✓
	MX C 400	✓
	MX C 401	✓
	MX M 260	✓
	MX M 310	✓

Sharp

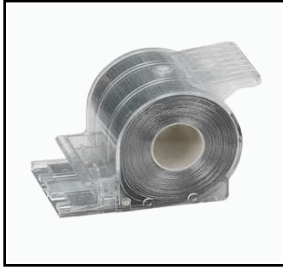

Katun Part Number

37796

Type Size (mm)
N1 76x46x46

Your Price:

Finisher	Model	OEM Part Number
MX- FN21		MX-SCX2
	MX 6240	✓
	MX 6500	✓
	MX 6580	✓
	MX 7040	✓
	MX 7500	✓
	MX 7580	✓
	MX M 1054	✓
	MX M 1055	✓
	MX M 1204	✓
	MX M 1205	✓
	MX M 654	✓
	MX M 754	✓
	MX M 904	✓
MX M 905	✓	
MX- FN22		MX-SCX2
	MX 6500	✓
	MX 6580	✓
	MX 7500	✓
	MX 7580	✓
	MX M 1054	✓
	MX M 1055	✓
	MX M 1204	✓
	MX M 1205	✓
	MX M 654	✓
	MX M 754	✓
	MX M 904	✓
	MX M 905	✓
	MX- FNX 5	
MX M 1100		✓
MX M 850		✓
MX M 950		✓
MX- FNX 6		MX-SCX2
	MX M 1100	✓
	MX M 850	✓
	MX M 950	✓

Sharp

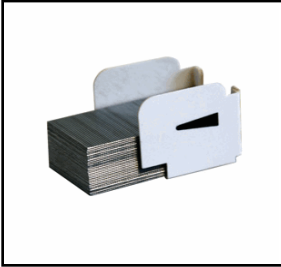

Finisher Model OEM Part Number

<u>Finisher</u>	<u>Model</u>	<u>OEM Part Number</u>
MX- FN25		MX-SCX3
	MX M 904	✓
	MX M 905	✓
MX- FNX 7		MX-SCX3
	MX M 1100	✓
	MX M 850	✓
	MX M 950	✓

Katun Part Number

47034

<u>Type</u>	<u>Size (mm)</u>
X1	36x21x12

Your Price: